

Instruction

Collection: Elegant
 Series: Torino
 Model: ARM139-08-W
 Suspended

A=9
 B=4

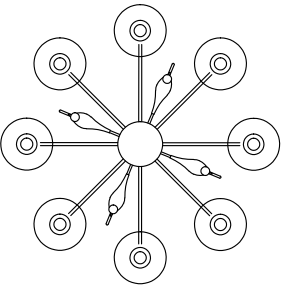
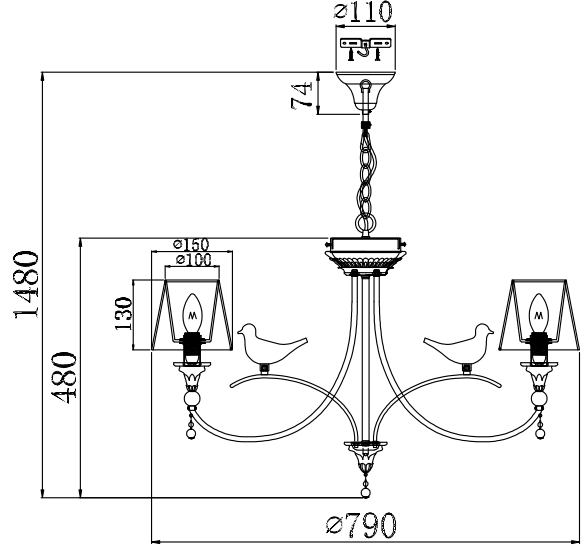
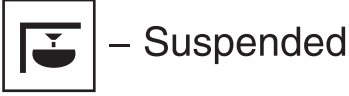
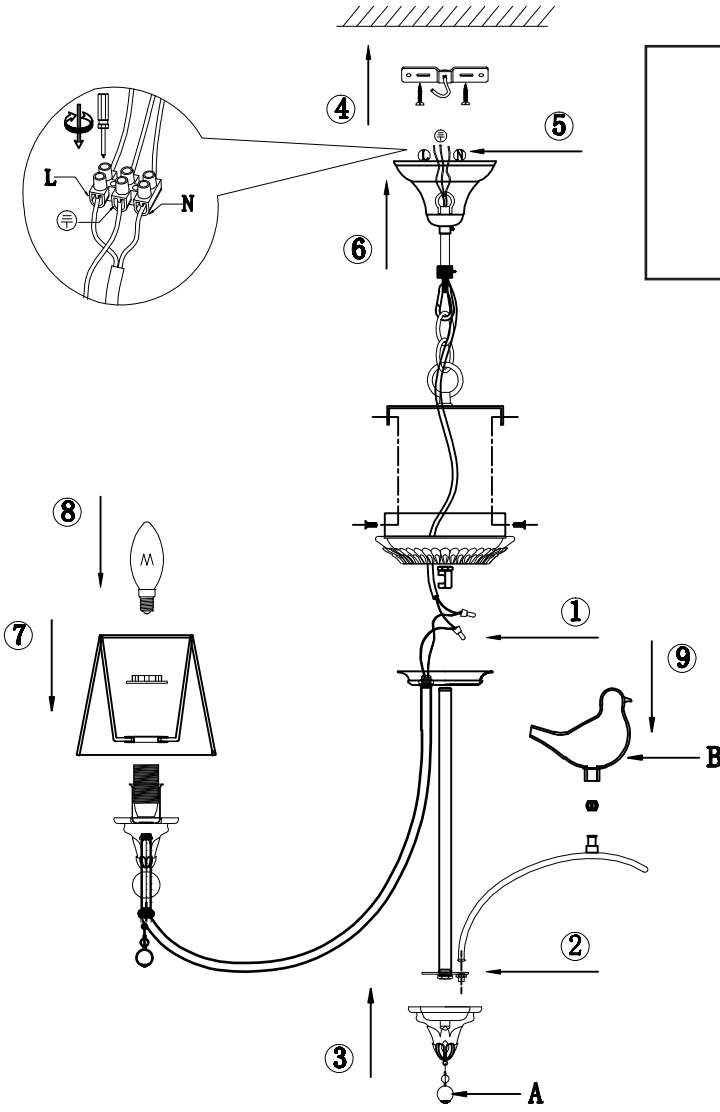

 8 x E14 (40w)

MAYTONI
 DECORATIVE LIGHTING
www.maytoni.de