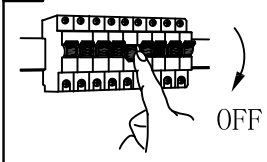
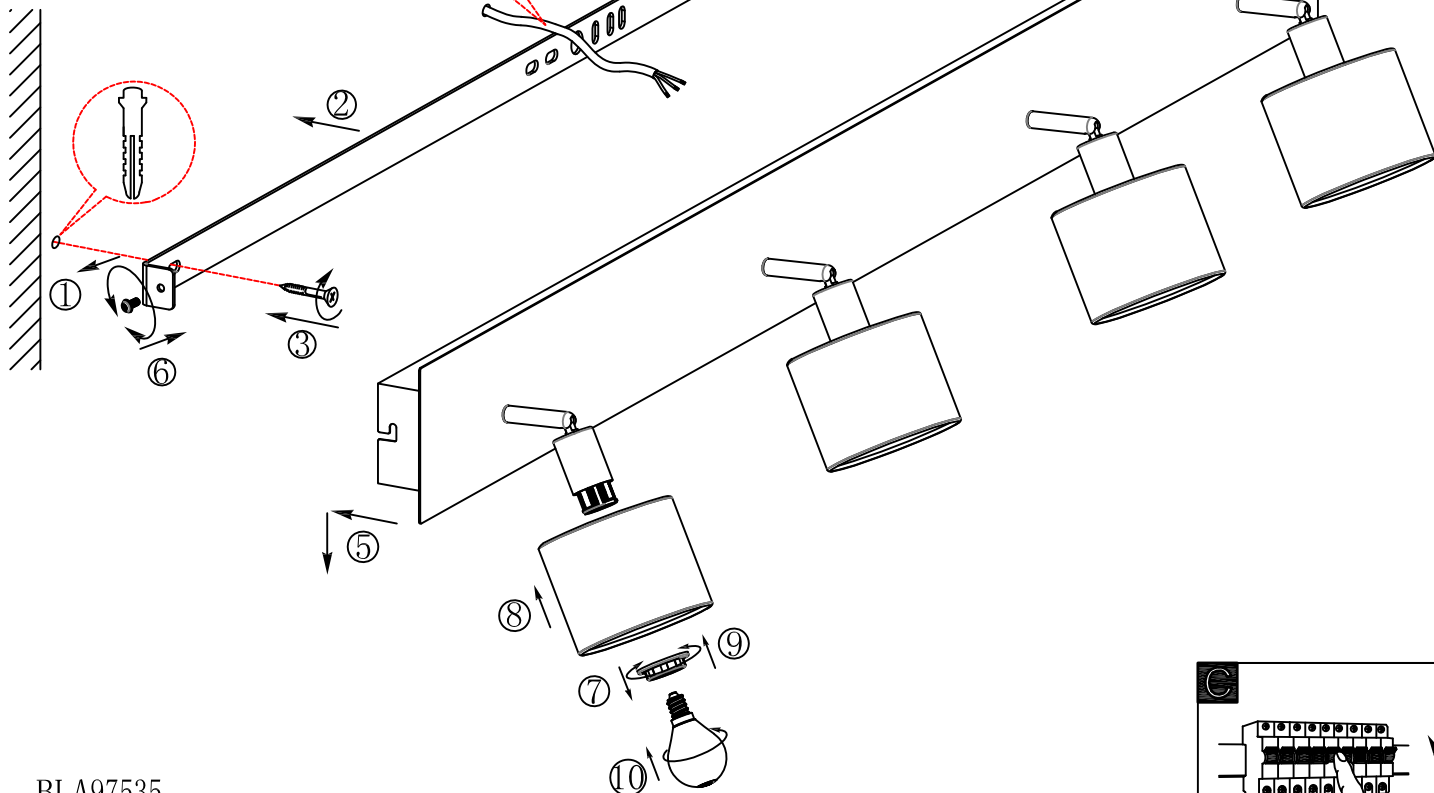
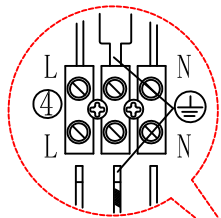

**A****B**

BLA97535  
www.eglo.com

**C**