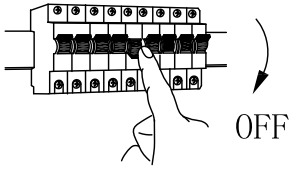
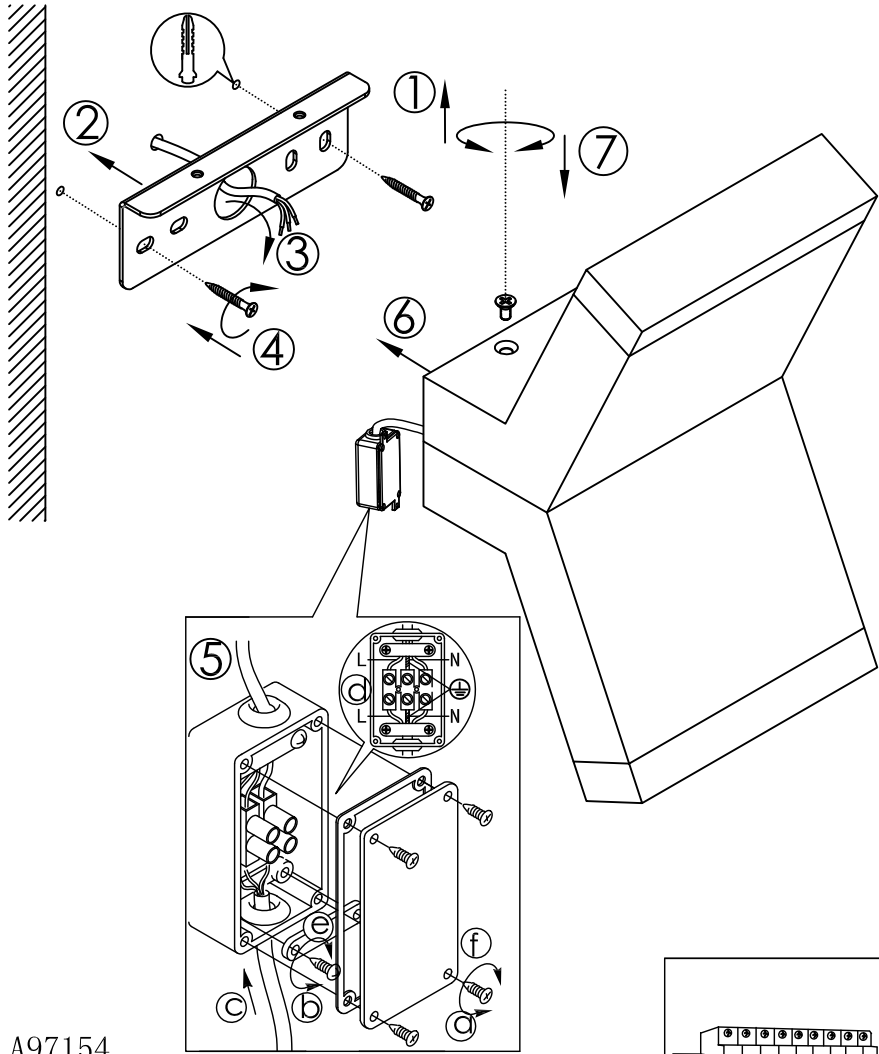
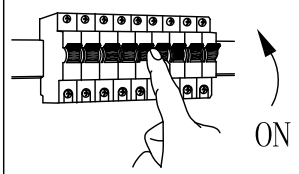

**A****B****C**

BLA97154  
www.eglo.com